

J.1

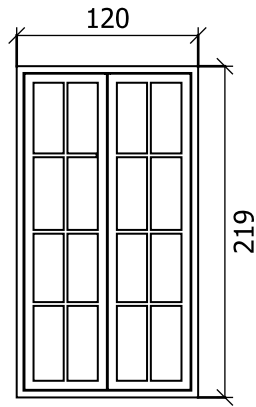

J.1.A

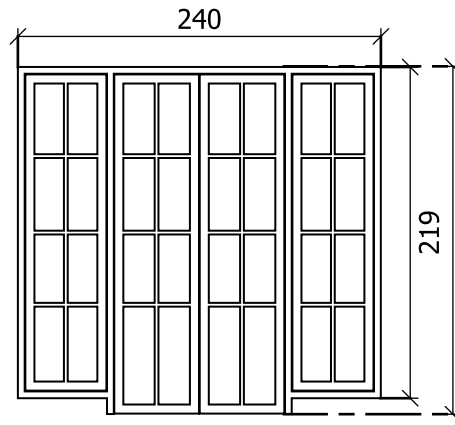

J.1.B

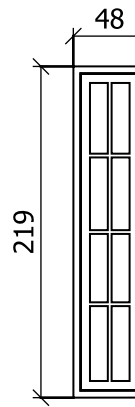

J.3

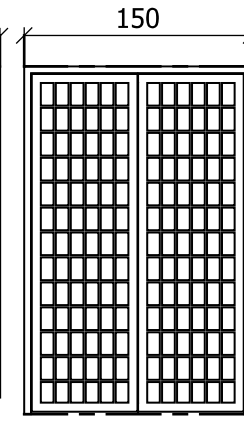

P.1

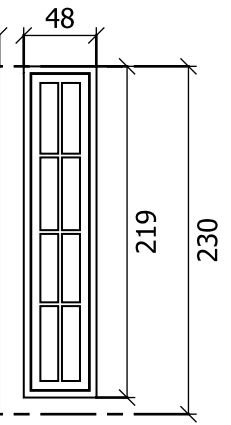

J.3

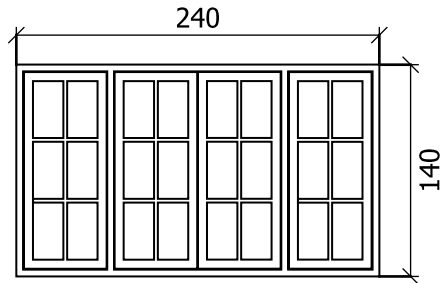

J.2.A

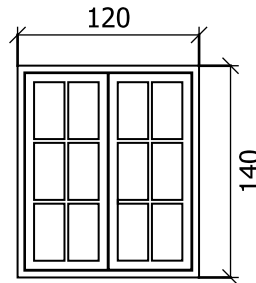

J.2

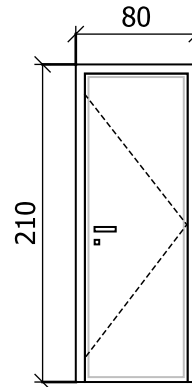

P.2

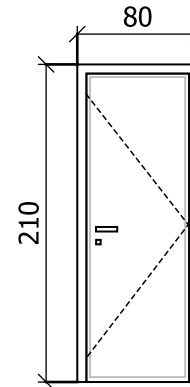

P.3

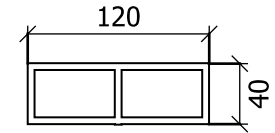

J.4

POTONGAN PINTU JENDELA
SKALA 1 : 50

DATA SHEET	
1	J.1 UNIT - 4 ALUMUNIUM 4"
2	J.1.A UNIT - 1 ALUMUNIUM 4"
3	J.1.B UNIT - 2 ALUMUNIUM 4"
4	J.2. UNIT - 3 ALUMUNIUM 4"
5	J.2.A UNIT - 2 ALUMUNIUM 4"
6	J.3 UNIT - 2 ALUMUNIUM 4"
7	J.4 UNIT - 4 ALUMUNIUM 4"
8	P.1 UNIT - 1 PINTU BAJA ex FORTRESS
9	P.2 UNIT - 6 PINTU BAJA EX FORTRESS
10	P.3 UNIT - 1 PINTU PVC ex PLATINUM

LEGEND :

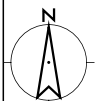

NO	DATE	AMANDEMEN DESCRIPTION	OWNER	PROJECT NAME	DRAWING TITLE	JOB NO		DRAW	CHECK	APPROVE	DRAW NO :
						DATE	SCALE				
				RUMAH HUNIAN PAKIS BARU, NAWANGAN PACITAN	POT. PINTU & JENDELA	16-10-2025	1:50				ARS-RT - A4-02